

# BASIC CUP HOLDERS WITH THREADED MALE AND FEMALE CONNECTORS

The actual springing stroke is:

- For height C= 28 mm      16 mm
- For height C= 65 mm      49 mm
- For height C= 95 mm      74 mm

## Basic cup holders with threaded female connectors

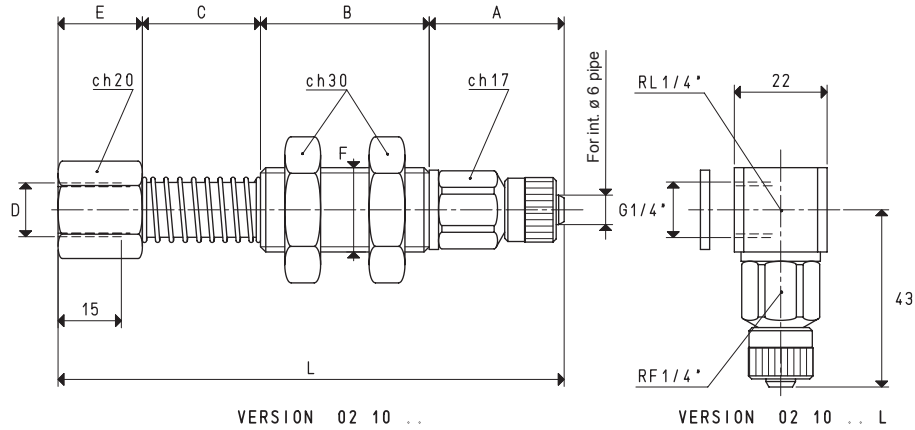
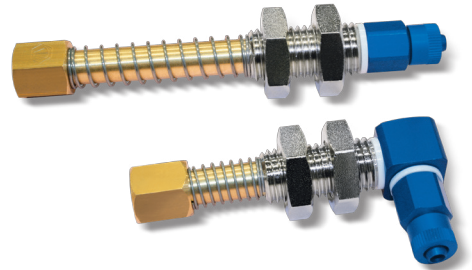

CUP HOLDERS WITH STRAIGHT QUICK COUPLER FOR PLASTIC HOSE Ø 6 X 8

Art.	A	B	C	D	E	F	L	Weight
				Ø		Ø		g
<b>02 10 28</b>	32	40	28	G1/4"	20	M20	120	224
<b>02 10 65</b>	32	40	65	G1/4"	20	M20	157	262
<b>02 10 95</b>	32	40	95	G1/4"	20	M20	187	289

**Note:** Add the letter L to the code to order L-type fittings.

## Basic cup holders with threaded male connectors

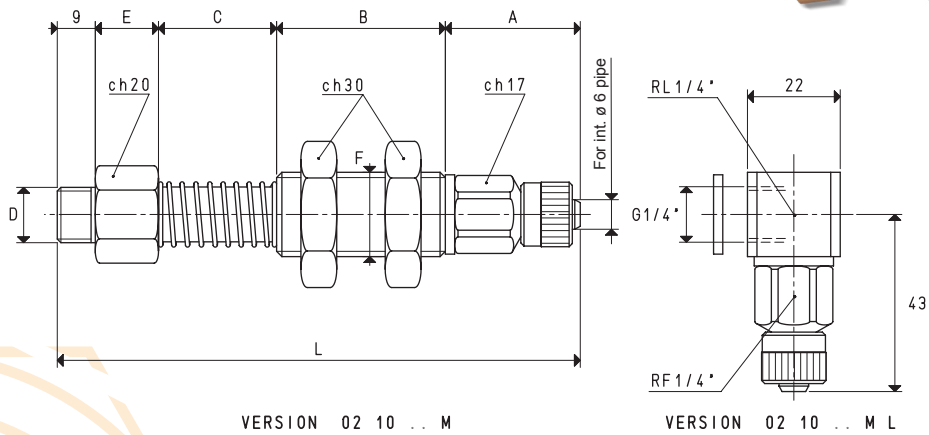
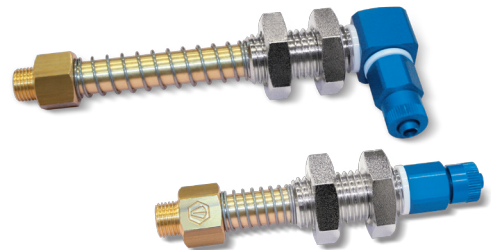

CUP HOLDERS WITH STRAIGHT QUICK COUPLER FOR PLASTIC HOSE Ø 6 X 8

Art.	A	B	C	D	E	F	L	Weight
				Ø		Ø		g
<b>02 10 28 M</b>	32	40	28	G1/4"	15	M20	124	225
<b>02 10 65 M</b>	32	40	65	G1/4"	15	M20	161	266
<b>02 10 95 M</b>	32	40	95	G1/4"	15	M20	191	295

**Note:** Add the letter L to the code to order L-type fittings.

3D drawings available at [www.vuototecnica.net](http://www.vuototecnica.net)

2.78

Conversion ratio: inch =  $\frac{\text{mm}}{25.4}$ ; pounds =  $\frac{\text{g}}{453.6} = \frac{\text{Kg}}{0.4536}$